

 **WARNING!**

Carefully read, follow and understand the instructions given in this manual. It is an essential part of the product, and you should keep it in a safe place for future reference.

**MECHANIC QUALIFICATION** - Please be advised that many bicycle service and repair tasks require specialized knowledge, tools and experience. General mechanical aptitude may not be sufficient to properly service or repair your bicycle. If you have any doubt whatsoever regarding your service/repair ability, please take your bicycle to a qualified repair shop.

**INTENDED USE** - These Campagnolo® wheels are designed and manufactured for use only on road racing style bicycles that are ridden only on smooth road or track surfaces. Any other use of these wheels, such as off-road or on trails is **forbidden**.

**"AN ACCIDENT"** - Please note that throughout this manual, reference is made that "an accident" could occur. Any accident could result in damage to your bicycle, its components and, more importantly, could cause you or a bystander to sustain severe personal injury or even death.

**LIFESPAN - WEAR - INSPECTION REQUIREMENT** - The lifespan of Campagnolo® wheels depends on many factors, such as rider size and riding conditions. Impacts, falls, improper use or harsh use in general may compromise the structural integrity of the components and significantly reduce their lifespan. Some components are also subject to wear over time. Please have your bicycle and its components regularly inspected by a qualified mechanic for any cracks, deformation, signs of fatigue or wear (use of penetrating fluid or other visual enhancers to locate cracks on parts is recommended). Disassembly your bicycle components and especially the pedals, is required during these inspections. If the inspection reveals any deformation, cracks, impact marks or stress marks, no matter how slight, immediately replace the component; components that have experienced excessive wear also need immediate replacement. The frequency of inspection depends on many factors; check with your authorized representative of Campagnolo S.r.l. to select a schedule that is best for you.

- If you weigh over 109 kg/240 lbs we advise you not to use this product. Non compliance with this warning can damage the product irreversibly.
- If you weigh 82 kg/180 lbs or more, you must be especially vigilant and have your bicycle inspected more frequently (than someone weighing less than 82 kg/180 lbs). Check with your mechanic to discuss whether the wheels you selected are suitable for your use, and to determine the frequency of inspections.

**Important PERFORMANCE, SAFETY and WARRANTY Notice** - The parts and components of Campagnolo® 9s, 10s, 11s drivetrains, braking systems, rims, pedals and all other Campagnolo® products, are designed as a single integrated system. To avoid compromises in terms of safety, performance, durability, function, and to prevent voiding the WARRANTY, use only the parts and components supplied or specified by Campagnolo S.r.l., without interfacing them with or substituting them with products, parts or components manufactured by other companies.

**Note:** Tools supplied by other manufacturers for components similar to Campagnolo® components may not be compatible with Campagnolo® components. Likewise, tools supplied by Campagnolo S.r.l. may not be compatible with components supplied by other manufacturers. Always check with your mechanic or the tool manufacturer to insure compatibility before using tools supplied by one manufacturer on components supplied by another.

*The user of this Campagnolo® product expressly recognizes that there are risks inherent in bicycle riding, including but not limited to the risk that a component of the bicycle can fail, resulting in an accident, personal injury or death. By his purchase and use of this Campagnolo® product, the user expressly, voluntarily and knowingly accepts and/or assumes these risks and agrees to hold Campagnolo S.r.l. harmless against any resulting damages.*

## USE OF THE MANUALS (PART 1 + PART 2)

### WARNING!

Carefully read, understand and follow the instructions given in both manuals (PART 1 + PART 2), that are an essential part of the product, and keep them for future reference.

Please be advised that many bicycle service and repair tasks require specialized knowledge, tools and experience.

General mechanical aptitude may not be sufficient to properly service or repair your bicycle. If you have any doubt whatsoever regarding your ability to properly service or repair your bicycle, please take your bicycle to a qualified repair shop. Improper adjustment or service can result in an accident, personal injury or death.

### BEFORE EVERY RIDE

DO NOT RIDE YOUR BICYCLE IF IT DOES NOT PASS THIS PRE-RIDE TEST CORRECT ANY CONDITION BEFORE YOUR RIDE.

- Be sure that all of the components of your bicycle, including but not limited to your brakes, pedals, handgrips, handlebars, frame and seating system, are in optimum condition and suitable for use.
- Be sure that none of the components of bicycle are bent, damaged or out of alignment.
- Check to be sure that all quick release fasteners, nuts and bolts are properly adjusted. Bounce the bicycle on the ground and listen and look for anything which may be loose.
- Be sure that your wheels are perfectly centred. Spin the wheels to be sure that they do not wobble up and down or from side to side, and that they do not make contact with the fork legs or brake pads while rotating.
- Check all reflectors to make sure that they are clean, straight and securely mounted.
- Check you brake pads and cables to be sure they are in good condition.
- Test your brakes in the beginning of your ride to make sure that they are operating properly.
- Learn and follow the local bicycle laws and regulations, and obey **all** traffic signals, signs and laws while you ride.

If you ever any comments, questions or concerns, please contact your nearest Campagnolo Service Center. A list of service centers may be found on our website at [www.campagnolo.com](http://www.campagnolo.com).

Campagnolo S.r.l. reserves to modify the content of this manual without notice.

The updated version will always be available [www.campagnolo.com](http://www.campagnolo.com).

On our website you will also find information on the other Campagnolo products and the spare parts catalogue.

## 1. TECHNICAL SPECIFICATIONS

### 1.1 - SHAMAL ULTRA FOR TUBULAR WHEELS

#### WHEEL TECHNICAL SPECIFICATIONS

|   |   |
|---|---|
| Rim diameter: 634 mm  | Quick release types: Front QF6-20 - Rear QR6-20   |
| O.L.D.:<br>front: 100 mm - rear: 130 mm                         | Inflation pressure: see the inflation pressure recommended by the producer of the tire. |
| Use: road racing on smooth road or track surfaces <b>only</b> . |   |

#### SPOKES TECHNICAL SPECIFICATIONS

### WARNING!

Only use genuine Campagnolo spokes for your specific type and model of wheel. Failure to use correct spokes can result in an accident, personal injury or death.

#### Front wheel:

- Spokes type: AERO ALUMINIUM
- Spokes number: 16
- Spokes length: 279 mm
- Recommended tension: 70÷90 Kg

#### Rear wheel - freewheel side:

- Spokes type: AERO ALUMINIUM
- Spokes number: 14
- Spokes length: 283 mm
- Recommended tension: 130÷150 Kg

#### Rear wheel - side opposite the freewheel:

- Spokes type: AERO ALUMINIUM
- Spokes number: 7
- Spokes length: 276 mm
- Recommended tension: 90÷110 Kg

## 1.2 - SHAMAL ULTRA FOR CLINCHER WHEELS

### WHEEL TECHNICAL SPECIFICATIONS

|   |   |
|---|---|
| Rim : 700C (622x15C)  | Quick release types: Front QF6-20 - Rear QR6-20 |
| O.L.D.:<br>front: 100 mm - rear: 130 mm                         | see table "Maximum operating pressures"         |
| Use: road racing on smooth road or track surfaces <b>only</b> . |   |

| MAXIMUM OPERATING PRESSURES | TYRE WIDTH     | mm   | 20               | 23                | 25               |
|-----------------------------|----------------|------|------------------|-------------------|------------------|
|                             |                | Inch | 0.80             | 0.90              | 1.00             |
|                             | RIM DIMENSIONS | 13C  | 8 BAR<br>116 PSI | 8 BAR<br>116 PSI  | 8 BAR<br>116 PSI |
|                             |                | 15C  |                  | 10 BAR<br>145 PSI | 9 BAR<br>131 PSI |

### SPOKES TECHNICAL SPECIFICATIONS



#### WARNING!

Only use genuine Campagnolo spokes for your specific type and model of wheel. Failure to use correct spokes can result in an accident, personal injury or death.

#### Front wheel:

- Spokes type: AERO ALUMINIUM
- Spokes number: 16
- Spokes length: 279 mm
- Recommended tension: 70÷90 Kg

#### Rear wheel - freewheel side:

- Spokes type: AERO ALUMINIUM
- Spokes number: 14
- Spokes length: 283 mm
- Recommended tension: 130÷150 Kg

#### Rear wheel - side opposite the freewheel:

- Spokes type: AERO ALUMINIUM
- Spokes number: 7
- Spokes length: 276 mm
- Recommended tension: 90÷110 Kg

## 2. TIRES

### 2.1 - SHAMAL ULTRA FOR TUBULAR WHEELS

- The wheel you have purchased is designed to use tubular tires.
- After mounting a suitable tubular tire to the wheel, check to see that the diameter and cross-section are compatible with dimension of the wheel.
- Use acetone to degrease the bonding surface of the rim before applying the glue for tubular installation.
- The installation of the tubular tire on the wheel is an operation that requires special attention. Refer to the instructions enclosed with the tubular tire before and during installation. We recommend, in most cases, applying at least three coats of glue to the rim and one coat to the tire and allow the tubular tire to "set" for at least twenty-four hours before using the wheel.



#### WARNING!

Failure to properly install the tire can cause sudden and unexpected loss of tire pressure, resulting in an accident, personal injury or death.



#### WARNING!

Do not sand-paper the rim before installing the tubular tire. Do not perform any operations which may cause abrasions, scratches or cuts to the rim or which may damage it in any other way. This damage could cause the rim to unexpectedly fail, resulting in an accident, personal injury or death.

### 2.2 - INFLATING AND DEFLATING THE TIRE

- **To inflate the tire:** 1) remove the cap, 2) unscrew the valve, 3) inflate the tire using a compressor or pump equipped with a pressure gauge to obtain the required pressure, then 4) tighten the valve and replace the cap.
- **To deflate the tire:** 1) remove the cap, 2) unscrew the valve, 3) press and hold down the valve to obtain the required pressure, then 4) tighten the valve and replace the cap.

**⚠ CAUTION!**

Never exceed the maximum inflation pressure recommended by the tire manufacturer.

Excessive tire pressure reduces the grip of the tire on the road and increases the risk that the tire will unexpectedly burst. Inflation pressure that is too low reduces tire performance and increases the probability of sudden and unexpected loss of tire pressure. In addition, premature wear and damage to the rim may occur.

**Note**

- The tire pressure should also be adjusted depending on the weight of the rider; a heavy rider should have a greater tire pressure than a light rider.

**⚠ WARNING!**

Incorrect tire pressure could cause tire failure or loss of control of the bicycle, resulting in an accident, personal injury or death.

**2.2 - SHAMAL ULTRA FOR CLINCHER WHEELS****⚠ WARNING!****Rim-Tire Compatibility**

Campagnolo rims are very precise dimensionally. If a tire is too easy to install on a Campagnolo rim, that tire is most likely too big and will not seat properly on the rim. If a tire is too difficult to install, that tire is most likely too small. Use only high quality tires that require the use of tire levers and a reasonable installation effort. Using talcum powder on the tire will make installation easier. Using a tire that does not fit properly on the rim can cause unexpected tire failure, resulting in an accident, personal injury or death.

- The wheel you have purchased is designed to use clincher tires.
- Before fitting the tires, check that the diameter indicated on the tire is 622 and that the cross-section is between 23 and 25 mm, to insure that the tire and wheel are compatible.

**⚠ WARNING!**

Failure to properly install the tire can cause sudden and unexpected loss of tire pressure, resulting in an accident, personal injury or death.

**INSTALLING CLINCHER TIRES**

Be sure that you do not damage or otherwise bend any portion of the rim when installing the tyre.

- Insert one side of the tyre into the seat provided on the rim (Fig. 1).
  - Insert the valve through the hole in the rim, and then position the remainder of the inner tube between the rim and the tyre.
  - In order to install the tube on the rim, inflate the tube slightly first.
  - You should then manually set the tube and tire on the rim, making sure that the tube is positioned correctly within the tire and that the tire is positioned correctly on the rim.
  - Insert the second side of the tyre into its seat in the rim.
- You may then fully inflate the tube to the correct working pressure. Please inflate the tube slowly, making sure that you maintain the correct positioning of the tube and tire on the rim.

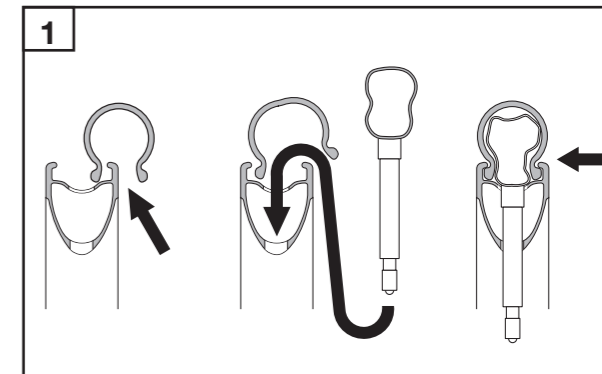
**INFLATING AND DEFLATING THE TIRE**

- **To inflate the tire:** 1) remove the cap, 2) unscrew the valve, 3) inflate the tire using a compressor or pump equipped with a pressure gauge to obtain the required pressure, then 4) tighten the valve and replace the cap.
- **To deflate the tire:** 1) remove the cap, 2) unscrew the valve, 3) press and hold down the valve to obtain the required pressure, then 4) tighten the valve and replace the cap.

**⚠ WARNING!**

- Never exceed the maximum pressure recommended by the tyre manufacturer.
- The inflating pressure of the tyres must NOT exceed the LOWER pressure level between the maximum pressure stated by the tyre manufacturer and the value recommended by the rim manufacturer.

Excessive tire pressure reduces grip on the road and increases the risk that the tire will unexpectedly burst.

Inflation pressure that is too low reduces tire performance and increases the probability of sudden and unexpected loss of tire pressure. In addition, premature wear and damage to the rim may occur.

**⚠ WARNING!**

Incorrect tire pressure could cause tire failure or loss of control of the bicycle, resulting in an accident, personal injury or death.

### 3. SPROCKETS ASSEMBLY AND REMOVAL



**WARNING!**

Always wear protective gloves and glasses while working on the sprockets.

#### 3.1 - 9S/10S CAMPAGNOLO® SPROCKETS (on Campagnolo® type FW body)

##### 3.1.1 - ASSEMBLY

- The sprockets are pre-assembled and timed on the plastic support (A - Fig. 1).
- Insert the support on the side of the freewheel body, align the spline patterns, press the sprockets onto the freewheel and extract the support (A) from the hub (Fig. 1).
- If installing the sprockets without the plastic support, install the individual or preassembled sprockets and the spacers on the sprocket body of the hub aligning the spline patterns (Fig. 2). The profile of the freewheel body with two asymmetrical grooves ensures automatic sprocket timing since there is only one assembly option.
- Using a torque wrench (D - Fig. 3) equipped with the Campagnolo® tool UT-BB080 (B - Fig. 3), tighten the locking (C - Fig. 3) on to the freewheel body to **50 N.m - 443 in.lbs.**

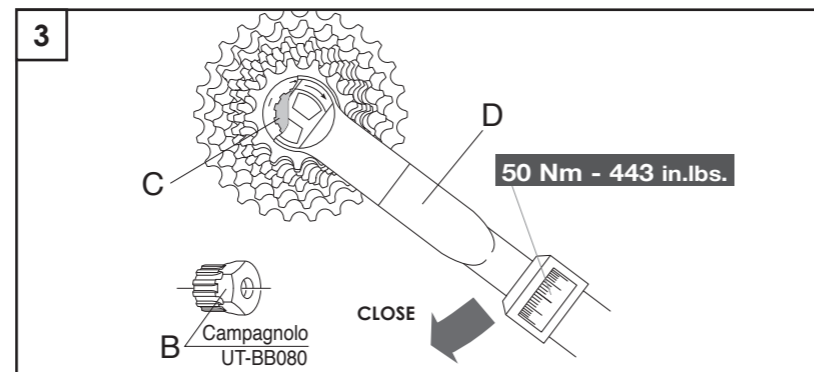
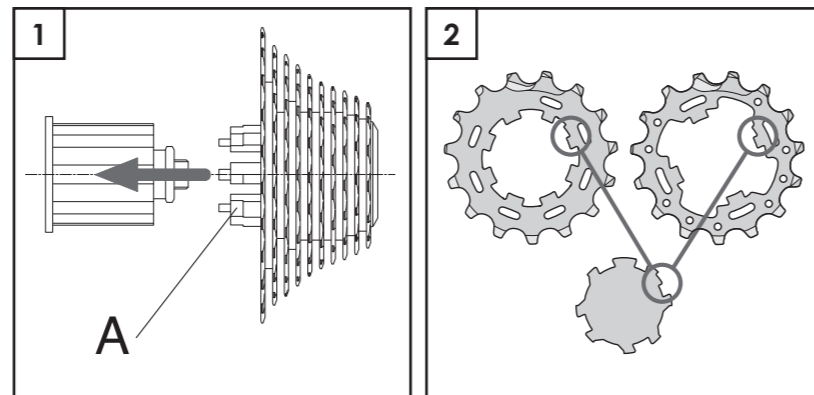

##### 3.1.2 - DISASSEMBLY

- Remove the locking (A - Fig. 4) using the Campagnolo® tool UT-BB080 (B - Fig. 4) with a 24 mm hexagonal wrench (C - Fig. 4) and the Campagnolo® chain whip UT-CS060 (Fig. 4).
- Insert the plastic sprocket carrier on the side of the freewheel body, align the spline patterns on the body with those on the carrier and slide the sprockets onto it.
- Slide the sprocket carrier, with the sprockets, off the freewheel body.

##### 3.2 - 11S SPROCKETS

- Refer to the instruction leaflet enclosed with the 11s sprockets for all the assembly, disassembly, use and maintenance operations.

#### 3.3 - 8S, 9S, 10S SPROCKETS FROM SHIMANO INC. and SPROCKETS FROM SRAM CORPORATION (on the Campagnolo freewheel body for Shimano Inc. 8/9/10s sprockets and Sram OG 1070 - OG 1090 sprockets)

##### 3.3.1 - ASSEMBLY

###### • SHIMANO INC. SPROCKETS

- 1) Fit the sprockets on the freewheel body and check that:
  - the surface with the name of the group of each sprocket is turned to the outside of the freewheel body.
  - the broadest groove of the sprocket (A - Fig. 5) and the broadest of the freewheel body (B - Fig. 5) are aligned.
- 2) If you fit a 10s sprocket set, you must first put the adaptor spacer provided with the sprockets onto the freewheel body (Fig. 6). This spacer is not necessary for 8s and 9s sprocket sets.

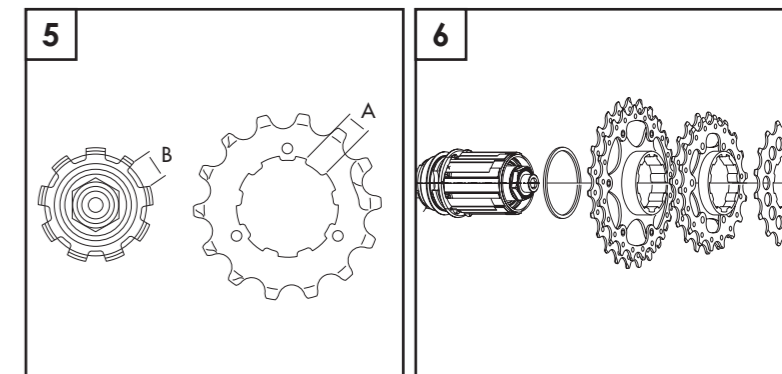
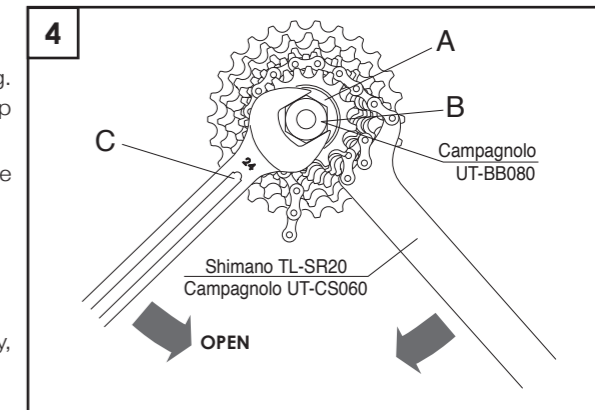

3) Using tool TL-LR15 from Shimano Inc. or FR-5 from Park Tool Co. (B - Fig. 7) tighten the lockring (C - Fig. 7) on the freewheel body to **30-50 Nm - 266-443 in.lbs.**

• **SRAM CORPORATION SPROCKETS**

- 1) The sprockets are preassembled on a support (A - Fig. 8).
- 2) Insert the support on the side of the freewheel body, align the grooves, press the sprockets onto the freewheel body and extract the support (A) from the hub (Fig. 8).
- 3) Using tool TL-LR15 from Shimano Inc. or FR-5 from Park Tool Co. (B - Fig. 7) tighten the lockring (C - Fig. 7) on the freewheel body to **30-50 Nm - 266-443 in.lbs.**

**3.3.2 - DISASSEMBLY**

- Remove the lockring (C - Fig. 7) using tool TL-LR15 from Shimano Inc. or FR-5 from Park Tool Co. (B - Fig. 7) and a chain whip (e.g. Shimano Inc. TL-SR20 - D - Fig. 7).
- Remove the sprockets from the freewheel body.

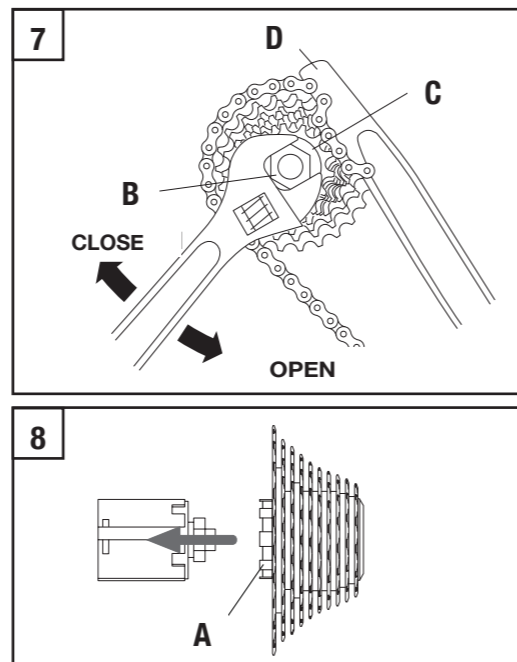

**4. BRAKES**

Please consult the instruction sheet supplied by the manufacturer.

**5. PERIODIC WHEEL MAINTENANCE AND SAFETY RECOMMENDATIONS**

**Note**  
 We recommend that you contact a specialized mechanic for all the assembly, disassembly and all hub, rim and spoke replacement operations. Choose with him the most suitable interval of inspections for you on the basis of the conditions of use and intensity of your activities (e.g. racing, rain, salted roads, muddy roads, cyclist's weight, etc.).

**! WARNING!**

All operations of the nipples should be performed using the special **T-07** tool, included in this kit. Use of other tools could damage the nipples failure resulting in an accident, personal injury or death.

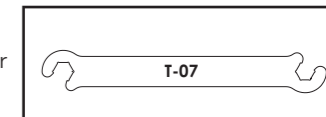

**ATTENTION! NOTE FOR SPECIALIZED MECHANICS**

**CONTACT YOUR CAMPAGNOLO SERVICE CENTER FOR THE INSTRUCTIONS FOR ASSEMBLING, MAINTAINING AND REPLACING RIMS, SPOKES AND HUBS, OR YOUR CAMPAGNOLO DEALER.**

**IMPORTANT NOTE**

**The nipple guide magnet, the magnetic nipple insert, and the spoke anti-rotation ring provided are necessary for replacing the spokes and must only be used by specialised mechanics.**

- Please be advised that if the maintenance and repair procedures provided in this manual are not properly performed, or if the other instructions in this manual are not followed, an accident could occur.
- Never make any modifications whatsoever to any component of any Campagnolo product.
- Parts which have been bent or otherwise damaged in an accident or as a result of any other impact must not be re-straightened. They must be replaced immediately with original Campagnolo parts.
- After using the wheel for the first time, check wheel trueness and circularity.

**! WARNING!**

**Using wheels that have not been centred properly or which have broken or damaged spokes may result in accidents, personal injury or death.**

- Check the tyres and their pressure before every race.
- At least once each month, please take your bicycle to a qualified mechanic to check the tension of the spokes, wheel centering and wheel dish and correct as necessary.

- Periodically bring the bike to a specialized mechanic to lubricate the hub bearings, ball bearings and FW gear with specific oil for bearings. The most suitable frequency of checks for you should be agreed with the mechanic himself on the basis of your weight and the intensity of your activity (approximately every 3,000/5,000 km – 1,860/3,000 miles). Every 10,000/20,000 km (6,000/12,000 miles) we recommend that you bring the bike to a specialized mechanic for lubrication, replacement, disassembly and inspection of the hubs.
- Wear clothes which are snug-fitting and which make you visible to traffic, such as neon fluorescent or other bright colors. Avoid biking at night because it is more difficult for you to be seen by traffic, and it is more difficult for you to see obstructions on the ground. If you do ride at night, you should equip your bicycle with and use a headlight and a tail light.
- Never use a bicycle or bicycle component unless you are thoroughly familiar with its use and maintenance history. “Used” equipment may have been misused and abused, and can unexpectedly fail resulting in an accident.
- Always wear a properly fitted and fastened bicycle helmet that has been approved by ANSI or SNELL.
- When riding in wet conditions, remember that the stopping power of your brakes is greatly reduced and the adherence of the tires to the ground is considerably reduced. This makes it harder to control and stop your bicycle. Extra care is required when riding your bicycle in wet conditions to avoid an accident. An accident could result in severe personal injury or death.

## CLEANING THE WHEELS

When cleaning the wheels, only use non-aggressive, non-corrosive products such as water and neutral soap, or specific products specially designed for cleaning bicycles. Absolutely never use abrasive or metal sponges. Dry with a soft cloth.

### Note

Never spray your bicycle with water under pressure.

Pressurized water, even from the nozzle of a small garden hose, can pass seals and enter into your Campagnolo components, damaging them beyond repair. Wash your bicycle and Campagnolo components by wiping them down with water and neutral soap.



## WARNING!

**Salt water environments (as found on winter roads and near the seaside) can cause galvanic corrosion on most bike parts. Carefully rinse, clean, dry and re-lubricate all exposed parts to avoid damage, malfunctions and accidents.**

## TRANSPORT AND STORAGE

When transporting the wheel separately from the bike or if the wheel will not be used for a long period of time, store it in the wheelbag to protect it against impacts and dirt.